

**Specifications:**

Sound level Category	Medium Sound Level
Mode of Operation	Fast Pulse
Mounting	Panel (see note B)
Voltage Rating	60 to 250 Vac/dc
Frequency	2900 Hz ±500 Hz
Loudness (Min. Voltage)	68 dB(A) min. @ 2 FT and 60 Vac/dc
Loudness (Max Voltage)	78 dB(A) min. @ 2FT and 250 Vac/dc
Current Draw	4 mA Max @ 60 Vac/dc
Current Draw	13 mA Max @ 250 Vac/dc
Min. Pulse Rate (PPS)	2 @ 60 Vac/dc
Max. Pulse Rate (PPS)	10 @ 250 Vac/dc
Duty Cycle (%)	50 (Approx)
Storage Temperature	-40°C to +85°C
Operating Temperature	-30°C to +65°C
Weight (Typical)	2.7 oz (76 g)
Housing	6/6 Nylon, Color Black
Options	For other options contact factory

**Dimensions:** Inches (mm)

**UL Recognized** 

**RoHS Compliant**

PART DIMENSIONS BEFORE CODE DATE 0810 5

PART DIMENSIONS AFTER CODE DATE 0811 1

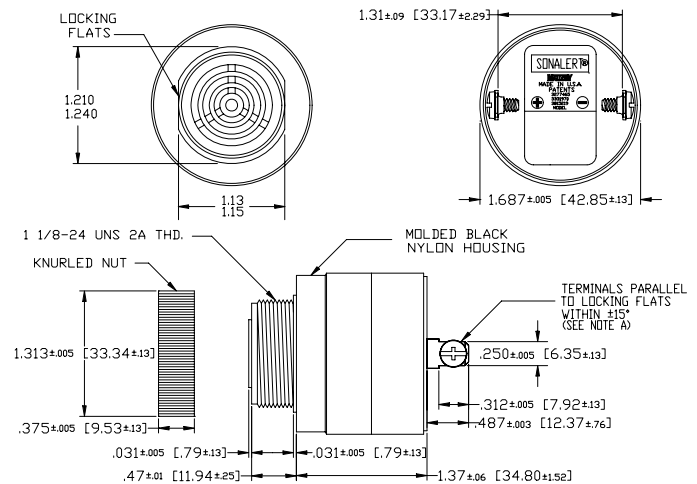
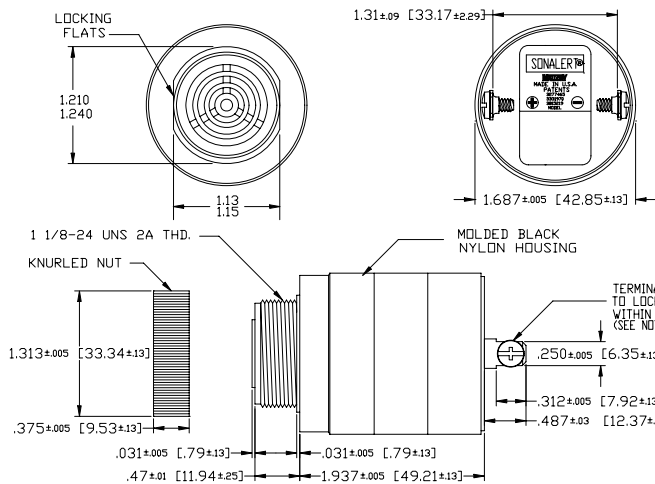

NOTE A: TERMINALS-.032 BRASS TIN PLATED, TAPPED FOR #6-32 SCREW. TWO #6-32 NICKEL PLATED BRASS SCREWS INCLUDED. WILL ACCEPT 1/4" QUICK CONNECT.

NOTE B: MOUNTING- REMOVE BLACK PLASTIC NUT AND INSERT THREADED FRONT THROUGH 1.25" HOLE PUNCHED IN PANEL, IF ORIENTATION IS NEEDED, NOTE LOCKING FLATS ON DRAWING. SCREW NUT BACK ON. DO NOT OVERTIGHTEN.

NOTE A: TERMINALS-.032 BRASS TIN PLATED, TAPPED FOR #6-32 SCREW. TWO #6-32 NICKEL PLATED BRASS SCREWS INCLUDED. WILL ACCEPT 1/4" QUICK CONNECT.

NOTE B: MOUNTING- REMOVE BLACK PLASTIC NUT AND INSERT THREADED FRONT THROUGH 1.25" HOLE PUNCHED IN PANEL, IF ORIENTATION IS NEEDED, NOTE LOCKING FLATS ON DRAWING. SCREW NUT BACK ON. DO NOT OVERTIGHTEN.